



01.08.2014

Dynamic Business Management Sp. z o.o.











Zapustna 14/1



02-483 Warszawa

+48 601 201 910

j.simpinska@d-b-m.pl

LISTWY ELEKTROINSTALACYJNE- cennik

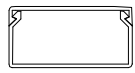
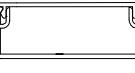
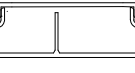
| L.p. | symbol | Przekrój | wymiary [mm] | dług.odc.[mb] | ilość w opak. [mb] | cena za mb.[zł] | Uwagi |
|------|----------|---|--------------|---------------|--------------------|-----------------|-------|
| 1 | LS 10x10 |  | 10x10 | 2 | 20 | 1,92 | |
| 2 | LS 15x10 |  | 15x10 | 2 | 20 | 2,01 | |
| 3 | LS 14x14 |  | 14x14 | 2 lub 2,5 | 20 lub 25 | 2,19 | |
| 4 | LS 20x14 |  | 20x14 | 2 lub 2,5 | 20 lub 25 | 2,41 | |
| 5 | LS 35x14 |  | 35x14 | 2 lub 2,5 | 20 lub 25 | 3,34 | |
| 6 | LS 17x15 |  | 17x15 | 2 | 20 | 2,26 | |
| 7 | LS 15x17 |  | 15x17 | 2 | 20 | 2,26 | |
| 8 | LS 30x17 |  | 30x17 | 2 | 20 | 3,83 | |
| 9 | LS 20x18 |  | 20x18 | 2 | 20 | 2,91 | |
| 10 | LS 25x18 |  | 25x18 | 2 | 20 | 3,6 | |

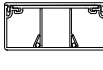
| | | | | | | | |
|----|-----------|---|-------|---|----|------|-----------------------------|
| 11 | LS 35x18 |  | 35x18 | 2 | 20 | 4,24 | |
| 12 | LS 50x18 |  | 50x18 | 2 | 20 | 5,17 | |
| 13 | LS 50x18P |  | 50x18 | 2 | 20 | 5,75 | stała przegroda |
| 14 | LS 25x25 |  | 25x25 | 2 | 20 | 3,74 | |
| 15 | LS 40x25 |  | 40x25 | 2 | 20 | 5,24 | opcja montażu separatora x1 |
| 16 | LS 60x25 |  | 60x25 | 2 | 20 | 7,36 | opcja montażu separatora x2 |

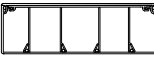
| | | | | | | | |
|----|-----------|---|--------|---|----|-------|-----------------------------|
| 17 | LS 40x40 |  | 40x40 | 2 | 20 | 6,84 | opcja montażu separatora x1 |
| 18 | LS 60x40 |  | 60x40 | 2 | 16 | 9,01 | opcja montażu separatora x2 |
| 19 | LS 90x40 |  | 90x40 | 2 | 16 | 11,85 | opcja montażu separatora x3 |
| 20 | LS 120x40 |  | 120x40 | 2 | 16 | 14,55 | opcja montażu separatora x4 |
| 21 | LS 60x60 |  | 60x60 | 2 | 16 | 8,69 | opcja montażu separatora x2 |
| 22 | LS 90x60 |  | 90x60 | 2 | 16 | 15,13 | opcja montażu separatora x3 |
| 23 | LS 130x60 |  | 130x60 | 2 | 12 | 22,66 | opcja montażu separatora x4 |
| 24 | P 25 |  | 21x5 | 2 | 20 | 1,52 | Separator |
| 25 | P 40 |  | 35x5 | 2 | 16 | 1,73 | Separator |
| 26 | P 60 |  | 55x5 | 2 | 16 | 2,25 | Separator |

Dostępne również listwy w kolorze szarym i ciemno brązowym +50% ceny

OSPRZĘT DO LISTEW ELEKTROINSTALACYJNYCH

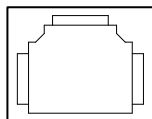

Trójknik
LO

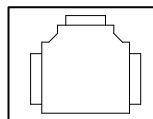

Trójknik redukcyjny
LOR

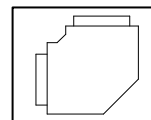

Łącznik kątowy
LK

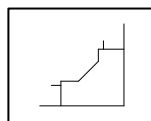

Narożnik wewnętrzny
NW

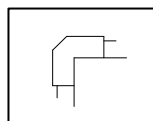

Narożnik zewnętrzny
NZ

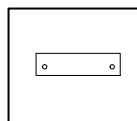

Zakończenie
SK

| LS 14/14 | cena |
|----------|------|
| LO-14 | 1,06 |
| LK-14 | 1,06 |
| NW-14 | 1,06 |
| NZ-14 | 1,06 |
| SK-14 | 1,06 |

| LS 20/14 | cena |
|----------|------|
| LO-20 | 1,06 |
| LOR20/14 | 1,06 |
| LK-20 | 1,06 |
| NZ-20 | 1,06 |
| NW-20 | 1,06 |
| SK-20 | 1,06 |

| LS 35/14 | Cena |
|----------|------|
| LO-35 | 1,06 |
| LOR35/14 | 1,06 |
| LOR35/20 | 1,06 |
| LK-35 | 1,06 |
| NW-35 | 1,06 |
| SK-35 | 1,06 |

| LS 60/40 | cena |
|----------|-------|
| LK-60/40 | 12,20 |
| NW-60/40 | 12,20 |
| NZ-60/40 | 12,20 |
| LO-60/40 | 12,20 |
| SK-60/40 | 6,35 |

| LS 90/40 | cena |
|----------|-------|
| LK-90/40 | 14,12 |
| NW-90/40 | 14,12 |
| NZ-90/40 | 14,12 |
| | |
| | |
| | |

| LS 90/60 | Cena |
|----------|-------|
| LK-90/60 | 15,01 |
| NW-90/60 | 15,01 |
| NZ-90/60 | 15,01 |
| SK-90/60 | 10,46 |
| | |
| | |

| LS 35/18 | cena |
|----------|------|
| LK-35/18 | 1,60 |
| NW-35/18 | 1,60 |
| NZ-35/18 | 1,60 |
| SK-35/18 | 1,60 |

| LS 50x18 | cena |
|----------|------|
| LK-50/18 | 3,13 |
| NW-50/18 | 3,13 |
| NZ-50/18 | 3,13 |
| SK-50/18 | 3,13 |

| LS | Cena |
|-----------|------|
| SK-20/18 | 1,06 |
| LK-20/18 | 1,63 |
| NW- 20/18 | 1,63 |
| NZ-20/18 | 1,63 |

| LS 17/15 | cena |
|----------|------|
| LO | 1,06 |
| LK | 1,06 |
| NW | 1,06 |
| NZ | 1,06 |
| SK | 1,06 |

| LS 40/25 | cena |
|----------|------|
| LK | 5,57 |
| NZ | 5,57 |
| NW | 5,57 |
| | |
| | |

| LS 40/40 | Cena |
|----------|------|
| LK | 7,16 |
| NZ | 7,16 |
| NW | 7,16 |
| SK | 5,66 |
| | |

| LS 25/18 | cena |
|-----------------|-------------|
| | |
| LK | 1,77 |
| NW | 1,77 |
| NZ | 1,77 |
| SK | 1,77 |

| LS 130/60 | Cena |
|------------------|-------------|
| LK | 25,85 |
| LO | 29,25 |
| NW | 25,85 |
| NZ | 25,85 |
| SK | 14,03 |

RURY KARBOWANE – RKBG, RKBGF

| LP | symbol | wymiary D(mm) | wym. D | ilość w opak. | Cena [mb.] | | | |
|----|---------|---------------|--------|---------------|------------|------|---------|---------------------|
| | | | | | RKBGF | RKBG | Rkkolor | RKBGszary, niepalny |
| 1 | O 16/12 | 16 | 12 | 50 | 0,56 | 0,62 | 0,68 | 0,78 |
| 3 | O 20/16 | 20 | 16 | 50 | 0,64 | 0,68 | 0,74 | 0,90 |
| 4 | O 25/21 | 25 | 20,5 | 50 | 0,74 | 0,78 | 0,84 | 0,98 |

RKBGF – palna

RKBG – niepalna(biała)

RK kolor – kolorowa(różne kolory)

RURY ELEKTROINSTALACYJNE

UCHWYTY

ZŁĄCZKI

| L.p. | symbol | dług.odc. [mb] | Ilość w opak. [szt.] | cena za szt.[zł] |
|------|--------|----------------|----------------------|------------------|
| 1 | RL 13 | 2,5 | 25 | 1,76 |
| 2 | RL 13 | 3 | 25 | 2,10 |
| 3 | RL 16 | 2,5 | 25 | 1,96 |
| 4 | RL 16 | 3 | 25 | 2,36 |
| 6 | RL 18 | 2,5 | 25 | 2,20 |
| 7 | RL 18 | 3 | 25 | 2,66 |
| 8 | RL 20 | 2,5 | 25 | 2,50 |
| 9 | RL 20 | 3 | 25 | 3,00 |
| 10 | RL 22 | 2,5 | 25 | 2,95 |
| 11 | RL 22 | 3 | 25 | 3,56 |
| 12 | RL 25 | 2,5 | 25 | 3,46 |
| 13 | RL 25 | 3 | 25 | 4,15 |
| 14 | RL 28 | 2,5 | 25 | 4,31 |
| 15 | RL 28 | 3 | 25 | 5,19 |
| 16 | RL 32 | 2,5 | 15 | 5,44 |
| 17 | RL 32 | 3 | 15 | 6,51 |
| 18 | RL 37 | 2,5 | 15 | 5,89 |
| 19 | RL 37 | 3 | 15 | 7,06 |
| 20 | RL 40 | 2,5 | 10 | 7,25 |
| 21 | RL 40 | 3 | 10 | 10,12 |
| 22 | RL 47 | 2,5 | 10 | 8,64 |
| 23 | RL 47 | 3 | 10 | 10,27 |
| 24 | RL 50 | 2,5 | 10 | 8,64 |
| 25 | RL 50 | 3 | 10 | 10,36 |
| 26 | RL 63 | 3 | 7 | 23,33 |

| symbol | cena za szt [zł] |
|--------|------------------|
| U 13 | 0,19 |
| U 16 | 0,21 |
| U 18 | 0,24 |
| U 20 | 0,28 |
| U 22 | 0,30 |
| U 28 | 0,30 |
| UZE 16 | 0,25 |
| UZE 18 | 0,27 |
| UZE 20 | 0,28 |
| UZE 22 | 0,31 |
| UZE 25 | 0,37 |
| UZE 28 | 0,35 |
| UZE 32 | 0,38 |
| UZE 37 | 0,55 |
| UZE 40 | 0,59 |
| UZE 47 | 0,61 |
| UZE 50 | 0,87 |
| UZE 63 | 1,05 |

| symbol | cena za szt. [zł] |
|--------|-------------------|
| ZCL 13 | 0,37 |
| ZCL 16 | 0,47 |
| ZCL 18 | 0,47 |
| ZCL 20 | 0,50 |
| ZCL 22 | 0,55 |
| ZCL 25 | 0,56 |
| ZCL 28 | 0,59 |
| ZCL 32 | 0,64 |
| ZCL 37 | 0,72 |
| ZCL 40 | 0,81 |
| ZCL 47 | 1,02 |
| ZCL 50 | 1,14 |
| ZCL 63 | 1,55 |

KOŁKI ROZPOROWE

| | | | |
|------------------------------------|--------------|-----------------------------|---------------|
| Koł.rozp. 6mm 3,5x35 | 5,97/100 szt | Koł.rozp. 8mm 4,0x45 | 7,81/100 szt |
| Koł.rozp. 6mm 3,5x40 | 6,63/100 szt | Koł.rozp. 8mm 5,0x50 | 14,36/100 szt |
| Koł.rozp. 6mm 3,5x50 | 7,08/100 szt | Koł.rozp. 8mm 5,0x60 | 16,10/100 szt |
| Koł.rozp. szybki montaż 6mm 4,0x40 | 7,45/100 szt | Koł.rozp. klucz 8mm 5,00x60 | 20,98/100 szt |

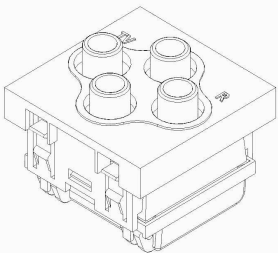
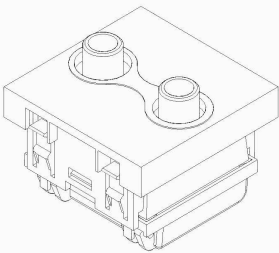
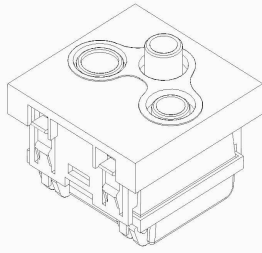

GNAZDA RTV i SAT do montażu w listwach

| gniazdo RTV SAT z dodatkowy wejściem SAT | Gniazdo RTV końcowe | gniazdo RTV SAT końcowe i przelotowe |
|---|---|---|
|  |  |  |
| P2VK 45x45 – 51,34 zł | PLK 45x45 – 26,58 zł | PVK1 45x45 -46,53 zł PVP – 57,32 zł |

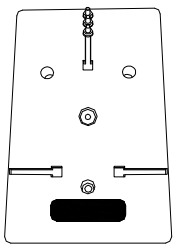
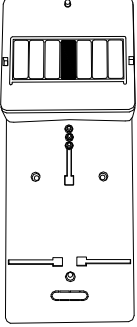
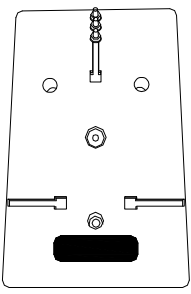
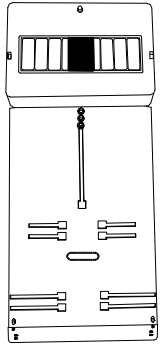

TABLICE PODLICZNIKOWE

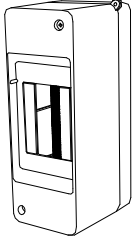
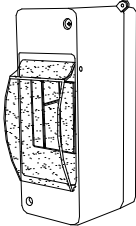
| | | | |
|---|---|--|---|
|  |  |  |  |
| 1 BZ 3,81 zł | 1S 16,00 zł | 3 BZ 5,69 zł | 3S 21,32 zł |

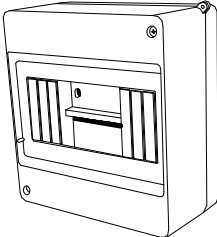
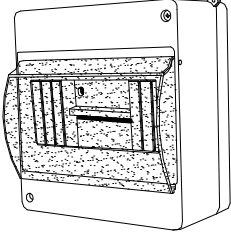
OBUDOWY IZOLACYJNE

| | | | | |
|---|---|---|--|---|
|  |  |  |  |  |
| S2 2,84 zł 140x97x50 | S2 z szybą 4,21 zł | S4 4,15 zł 140x97x65 | S6 10,64 zł 140x97x130 | S6 z szybą 16,18zł |

PUSZKI ELEKTROINSTALACYJNE

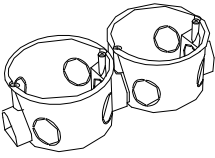
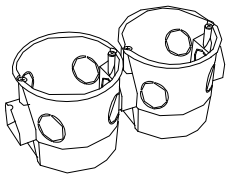
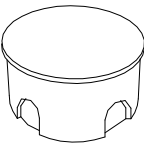
| | | |
|--|--|---|
|  |  |  |
| PKK-60 0,40 zł | PKD-60 0,0,58 zł | POT-70 0,44 zł |
|  |  |  |
| PKKŁ 0,47 zł | PKDŁ 0,59 zł | POT-80 0,58 zł |

1.podtynkowe

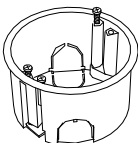
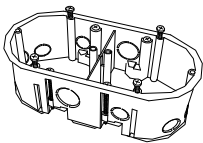
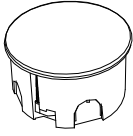
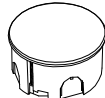
| | |
|---|---|
|  |  |
| PKG1-60 1,79 zł | PKG2-60 4,18 zł |
|  |  |
| POG-80 1,91 zł | POG-70 1,91 zł |

1.podgipsowe

3.natynkowe

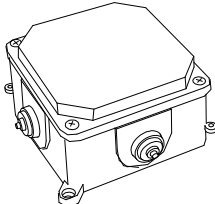
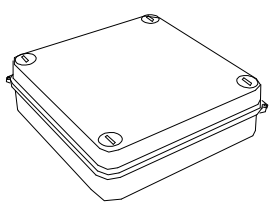
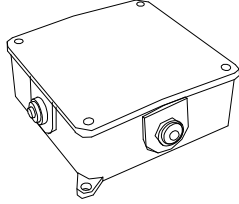
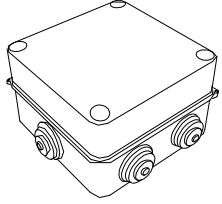
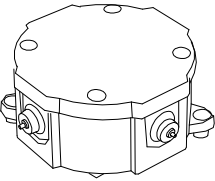
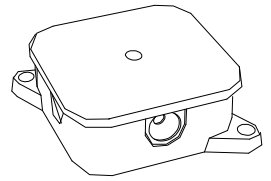
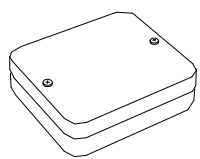
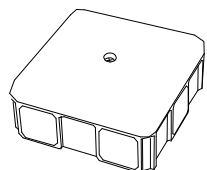
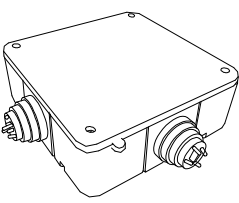
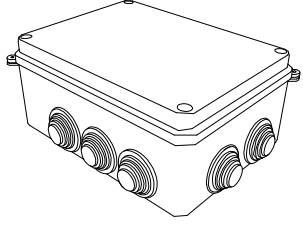
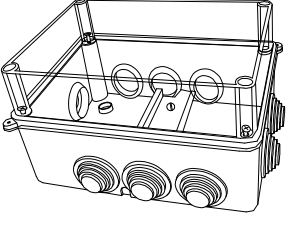
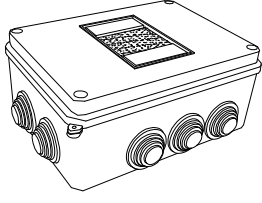
| | | | |
|--|--|---|--|
|  |  |  |  |
| PKN2 4,79 zł 60x100x100 | PKN3 5,79 zł 40x128x128 | PKN4 7,99 zł 60x128x128 | PKN5 9,79zł 80x128x128 |
|  |  |  |  |
| P1 pusta 2,19 zł 80x36 | P2 pusta 2,38 zł 35x85x85 | P4 3,07 zł 25x80x90 | PO6-PU 4,03 zł 35x85x85 |
| P1 pełna 3,65 zł 80x36 | P2 pełna 4,11 zł 35x85x85 | | |
|  |  |  |  |
| P6 9,26 zł 50x130x130 | P9 8,38 zł 70x115x155 | P10 15,51 zł 70x115x155 | P11 12,20 zł 70x115x155 |

Montaż w listwach elementów 45mmx45mm

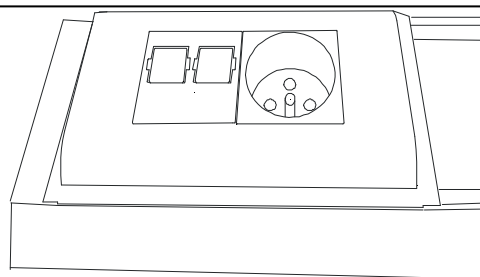

SUPPORTY SYSTEMOWE

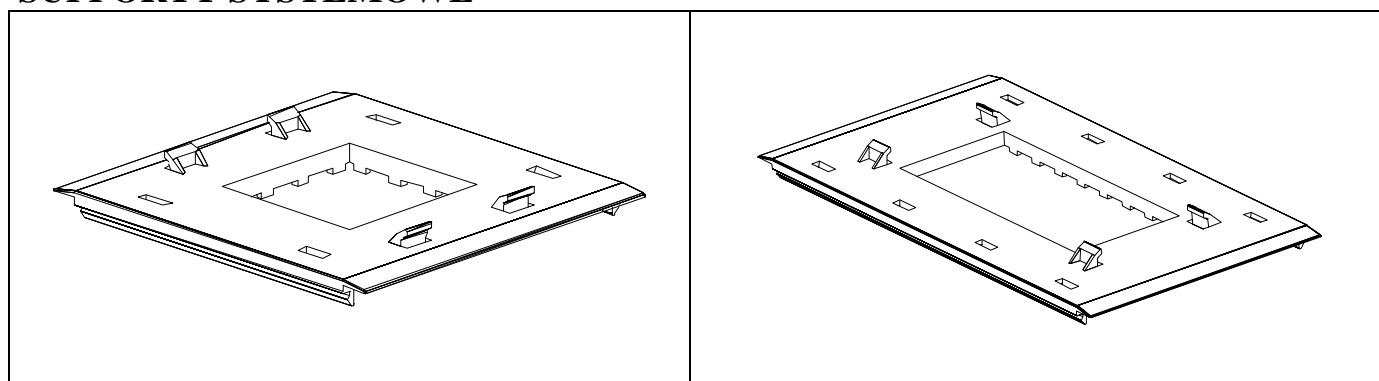

SUP-2 2,29 zł

SUP-4 3,01 zł

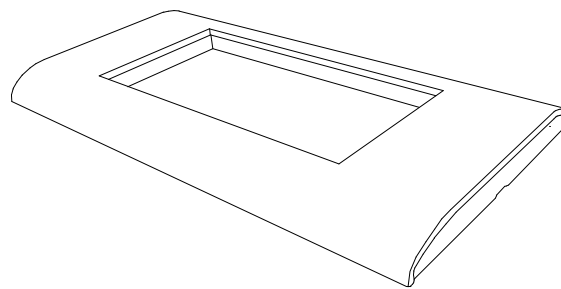
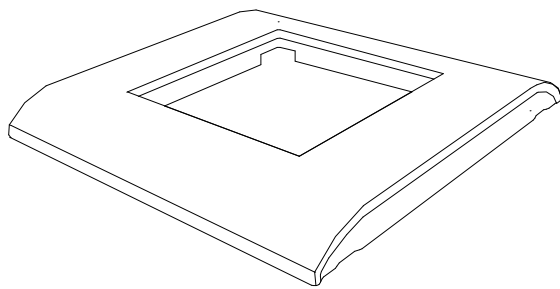
RAMKI MASKUJĄCE

RAM-2 2,75 zł

RAM-4 6,29 zł

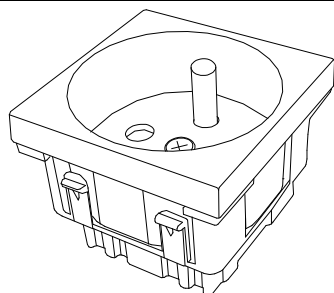
AKCESORIA SYSTEMOWE

GB 12,04 zł – gniazdo białe bez blok.

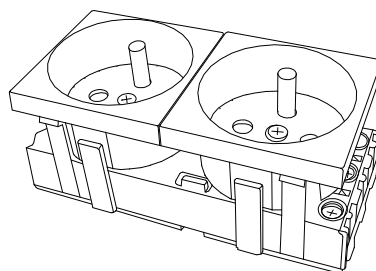

GBx2 29,52 zł ; GCx2 40,55 zł

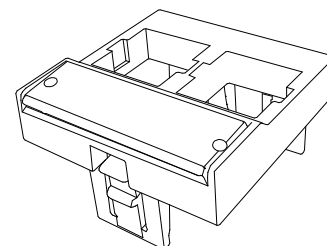
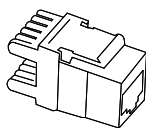
AD-1 7,53 zł
adapter 22,5x45

RJ-45 13,69 zł

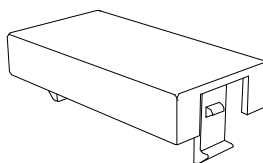
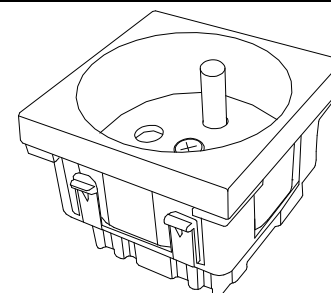
ZS-1 1,99 zł
zaślepka
22,5x45

GC 16,91 zł- gniazdo czerw z blok., Klucz – 2,95 zł

RJ-11 5,02 zł

ZS-2 2,23 zł
zaślepka 45x45